



COR IBR1700 Spec Sheet



INTRODUCTION

WHAT'S IN THE BOX

- High-performance hardened metal router with integrated business-class 3G/4G modem; includes integrated mounting plate
- Quick Start Guide with warranty information
- DC GPIO/power cable

KEY FEATURES

WAN

- Dual-modem capable with MC400 modem slot for 2nd modem
- 600M: LTE Advanced 600 Mbps LTE/HSPA+ (SIM-based, Auto-carrier Selection for all North American, European, and Asia Pacific carriers; includes support for 700 MHz Band 28 in Asia Pacific)
- WiFi as WAN, with WPA2 Enterprise Authentication for WiFi as WAN²
- 3rd radio for dedicated back haul
- WiFi client mode
- Failover/Failback
- Load Balancing
- Advanced Modem Failure Check
- WAN Port Speed Control
- WAN/LAN Affinity
- IP Passthrough
- Standby
- Multi-PDN
- Smart WAN Selection
- Serial PAD mode
- DynDNS
- AutoQoS
- QoS (DSCP and Priority Queuing)

LAN

- VLAN 802.1Q
- DHCP Server, Client, Relay
- DNS and DNS Proxy
- DMZ
- Multicast/Multicast Proxy
- MAC Address Filtering
- STP2
- GPS broadcast to LAN

WIFI

- Dual-Band, Simultaneous Tri Band 2×2 2.4GHz + 2×2 5GHz + 4×4 5GHz WiFi
- 802.11 a/b/g/n/ac wave 2 MU-MIMO and 256 QAM support
- Up to 192 connected devices (64 per radio – one @ 2.4 GHz and two @ 5 GHz)
- Multiple SSIDs: 2 per radio (6 total)
- WPA2 Enterprise (WiFi)
- Hotspot/Captive Portal
- SSID-based Priority
- Client Mode for faster data offload

MANAGEMENT

- Cradlepoint NetCloud Manager¹
 - Secure remote cloud configuration²
 - Real-time diagnostics/troubleshooting²
 - Remote connect / Out-of-Band Management²
 - Geoview location services
 - Pool data alerts²
- Client and Traffic Visibility and Control²
- Web UI, API, CLI
- Active GPS support
- Data usage alerts
- Advanced troubleshooting (support)
- Device alerts
- SDK support
- SNMP
- SMS control
- Serial redirector
- Auto APN Recovery
- Syslog

VPN & ROUTING

- IPsec Tunnel – up to ten concurrent sessions
- IKEv2 support (includes MOBIKE)
- L2TP2
- GRE Tunnel
- OSPF/BGP/RIP2
- Route Filters (Access Control Lists, Prefix Filters, Route Maps, Communities for BGP)
- Per-Interface Routing
- Policy-based Routing
- NAT
- NAT-less Routing
- WAN Affinity
- Virtual Server/Port Forwarding
- NEMO/DMNR²
- IPv6
- VRRP2
- NHRP2
- VTI Tunnel support²
- OpenVPN support²

SECURITY

- NetCloud Perimeter compatible
- RADIUS and TACACS+ support*
- 802.1x authentication for Ethernet**
- Zscaler Internet Security Compatible²
- Certificate support
- Application-level gateways
- MAC Address Filtering
- Advanced Security Mode (local user management only)
- FIPS 140-2 Inside version available
- Application-aware firewall
- IP Filtering
- Content Filtering
- Zone-Based Object Firewall with host address (IP or FQDN), port, and MAC address

*-Native support for authentication. Authorization and accounting support through hotspot/captive portal services.

**-802.1x Authentication for Ethernet not available for FIPS SKUs.

1 – [NetCloud Manager](#) requires a subscription

2 – Requires an [Extended Enterprise License](#) and [NetCloud Manager](#)

SPECIFICATIONS

WAN:

- Dual-modem capable with MC400 slot
- Integrated 600M LTE Advanced 600 Mbps modem (with DC-HSPA+ failover)
- Five LAN/WAN switchable 10/100/1000 Ethernet ports – one default WAN (cable/DSL/T1/satellite/Metro Ethernet)
- WiFi as WAN, Metro WiFi; 2×2 MIMO “N” 2.4 GHz or 4×4 5 GHz; 802.11 a/b/g/n/ac wave 2

LAN:

- Simultaneous Tri-Band WiFi; 802.11 a/b/g/n/ac wave 2
- Five LAN/WAN switchable 10/100/1000 Ethernet ports – four default LAN

PORTS:

- Power + GPIO (1 input / ignition sense input, 1 output)
- 20-pin power + GPIO port:
 - Alternate DC power input
 - Two analog inputs
 - One input / ignition sense input
 - Four configurable input/output
 - One low current 5V output (50mA max)
- USB 2.0
- Five Ethernet LAN/WAN
- Two cellular antenna connectors (SMA)
- One active GPS antenna connector (SMA)
- Six WiFi antenna connectors (R-SMA)

TEMPERATURE:

- -30 °C to 70 °C (-22 °F to 158 °F) operating

HUMIDITY (non-condensing):

- 5% to 95% operating
- 5% to 95% storage

POWER:

- DC input steady state voltage range: 9–36 VDC (requires 5.0A inline fuse for vehicle installations)
- Reverse polarity and transient voltage protection per ISO 7637-2
- Ignition sensing (automatic ON and time-delay OFF)
- Power consumption:
 - Conditions: 12V input, room temperature)
 - Sleep: 10 mW
 - Idle: 8 W
 - Typical: 14 W
 - Heavy Usage: 24 W
- Analog to Digital Converter:
 - Port 1: Selectable 0.5–36 V or 0.1–5 V ranges
 - Port 2: 0.5–36 V range
 - Accuracy: Typical \pm 0.5%, Maximum \pm 1%
 - Configurable low and high voltage alerts
 - Low voltage router shutoff

WIFI POWER (FCC):

- 2402–2483.5 MHz (2.4 GHz band): 29.2 dBm conducted
- 5150–5250 MHz (5 GHz band 1): 29.0 dBm conducted
- 5725–5850 MHz (5 GHz band 3): 30.0 dBm conducted

WIFI POWER (Europe/Rest of World):

- 2.4 GHz band: 19.81 dBm EIRP
- 5150-5250 MHz: 22.80 dBm EIRP

SIZE: 8.8 × 7.5 × 1.7 in (224.3 × 190 × 44 mm)

WEIGHT: 3 lb 7 oz (1.7 kg)

MATERIAL: metal

CERTIFICATIONS:

- FCC, CE, IC
- AS, NZS, SGP
- WiFi Alliance – 802.11a/b/g/n/ac wave 2 certified
- Safety: UL/CUL, CB Scheme, EN60950-1
- Shock/Vibration/Humidity: compliant with MIL STD 810G and SAEJ1455
- Ingress Protection: compliant with IP64 (includes protection from dust and splashing water)
- Materials: WEEE, RoHS, RoHS-2, California Prop 65
- Telecom: PTCRB/CTIA, GCF-CC
- Regulatory Models: S5A803A, S5A804A, S5A808A, S5A809A
- FIPS 140-2 Inside

GPS:

- GPS Protocols: NMEA 0183 V3.1
- Satellite channels: Maximum 48 channels, simultaneous tracking
- Concurrent standalone GPS, GLONASS, BeiDou, and Galileo
- 1 Hz refresh rate
- Accuracy:
 - Horizontal: < 1.7 m (50%)
 - Velocity: < 0.1 m/s
- Acquisition (measured with signal strength = -130 dBm):
 - Hot start: < 1.3 seconds
 - Warm start: < 31 seconds
 - Cold start: < 32 seconds
- Sensitivity
 - Tracking: -163 dBm (tracking sensitivity is the lowest GNSS signal level for which the device can still detect an in-view satellite 50% of the time when in sequential tracking mode)
 - Acquisition (standalone): -147 dBm (acquisition sensitivity is the lowest GNSS signal level for which the device can still detect an in-view satellite 50% of the time)
- Operational limits: altitude <18000 m and velocity <515 m/s

ACCESSORIES

Cradlepoint offers several accessory options for extensibility, power and antennas:

POWER & MOUNTING:

- Two meter locking power and GPIO cable (direct wire) (Part # 170585-000)
- COR extended temperature (-30C to 70C) power supply (line cord not included) Part #: 170648-001
- US line cord Part #: 170623-001
- EU line cord Part #: 170623-002
- UK line cord Part #: 170623-003
- AU line cord Part #: 170623-004
- IBR1700 Rack-Mount Brackets Part #: 170750-000

ANTENNAS – 3G/4G Modem, WiFi, & GPS:

- 700 MHz – 2700 MHz Wide Band Directional Antenna (Yagi/Log- Periodic) Part #: 170588-000
- 12" Mag-Mount Antenna with SMA Male Connector Part #: 170605-000
- 4" Mini Mag-Mount Antenna with SMA Male Connector Part #: 170606-000
- 2.4/5 GHz Dual-band, Dual-concurrent WiFi Antenna Part #: 170628-000 (WiFi models only)
- Universal 3G/4G/LTE Modem Antenna Part #: 170649-000
- GPS Screw-Mount Antenna Part #: 170651-000
- GPS Mag-Mount Antenna Part #: 170652-000
- Multi-Band Omni-Directional Antenna Part #: 170668-000
- Indoor/Outdoor Panel Patch Part #: 170669-000
- Universal LTE/4G/3G / 2dBi/3dBi antenna with SMA connector for all AER, ARC, COR, and MC400 products (Part # 170704-001)

VEHICLE ANTENNAS:

- 3-in-1 GPS & Modem Screw-Mount Part #: 170653-000
- 3-in-1 Adhesive-Mount Antenna Part #: 170653-001
- 5-in-1 GPS, Modem & WiFi Screw-mount Part #: 170654-000
- Low Profile 5-in-1 MIMO LTE, MIMO WiFi (2.4/5 GHz), & GPS Screw Mount Antenna with 5M Cables Part #: 170654-001

See the Cradlepoint antenna accessories page for more information about antennas. Also see the Antenna Ordering and Installation Guide, available as a PDF in the Resources section of antenna and router product pages.

BUSINESS-GRADE MODEM SPECIFICATIONS

COR IBR1700-600M models include an embedded LTE Advanced 600 Mbps 4G LTE modem. The 600M modems support Worldwide, SIM-based, Auto-carrier selection. Simply insert the SIM and wait for the router to automatically detect the SIM and establish a connection.

The LTE bands certified for each carrier are listed below.

COR IBR1700-600M

- Technology: LTE Advanced, HSPA+
- Downlink Rates: LTE 600 Mbps, HSPA+ 42.2 Mbps
- Uplink Rates: LTE 75 Mbps, HSPA+ 5.76 Mbps
- Frequency Bands:
 - LTE Bands
 - LTE FDD: 1–5, 7–8, 12–13, 17, 20, 25–26, 28–30, 66
 - LTE TDD: 38, 40–41
 - HSPA+: 1–2, 4–5, 8
 - LTE 2DL Carrier Aggregation Combinations:
 - B2+B2, B2+B4, B2+B5, B2+B12, B2+B13, B2+B17, B2+B29, B2+B30, B4+B4, B4+B5, B4+B7, B4+B12, B4+B13, B4+B17, B4+B29, B4+B30, B5+B30, B12+B12, B12+B30, B25+B25, B25+B26, B25+B41, B26+B41, B29+B30, B41+B41, B1+B20, B3+B3, B3+B7, B3+B20, B3+B38, B7+B7, B7+B8, B7+B20, B38+B38, B1+B3, B1+B7, B1+B28, B3+B8, B3+B28, B5+B7, B5+B40, B7+B8, B7+B20
 - LTE 3DL Carrier Aggregation Combinations:
 - B2+B2+B12/17, B2+B2+B13, B2+B2+B4, B2+B4+B5, B2+B4+B12, B2+B4+B13, B2+B4+B29, B2+B5+B30, B2+B12+B12, B2+B12+B30, B2+B29+B30, B4+B4+B5, B4+B4+B7, B4+B4+B12, B4+B4+B13, B4+B5+B30, B4+B12+B12, B4+B12+B30, B4+B29+B30, B25+B26+B41, B25+B41+B41, B26+B41+B41, B41+B41+B41, B1+B3+B20, B1+B7+B20, B3+B3+B7, B3+B3+B20, B3+B7+B20, B3+B7+B7, B3+B20+B38, B3+B38+B38, B3+B3+B5, B3+B3+B8, B3+B7+B7, B3+B7+B28, B7+B7+B28, B28+B40+B40, B40+B40+B40
- Fallback: WCDMA/DC-HSPA+ (42/5.76 Mbps): Bands 1, 2, 4, 5, 8
- Power: LTE 23 dBm ± 1, HSPA+ 23 dBm ± 1
- Antennas: two SMA male (plug), finger tighten only (maximum torque spec is 7 kgf/cm2)
- GPS: active GPS support
- SMS: SMS support
- Industry Standards & Certs: CE, FCC, GCF-CC, IC, PTCRB, AT&T, Sprint (pending), Verizon, Verizon NEMO/DMNR for Primary Wireless Access

SUPPORT & WARRANTY

The COR IBR1700 is only sold as a component of NetCloud Solution Packages.

- NetCloud Solution Packages include support for the full subscription term.
- All Cradlepoint hardware products are covered by a Limited Lifetime Warranty for as long as they are under a NetCloud Solution Package subscription.

The COR IBR1700 includes a minimum three-year hardware warranty when purchased from an authorized Cradlepoint Partner.

HARDWARE

TOP

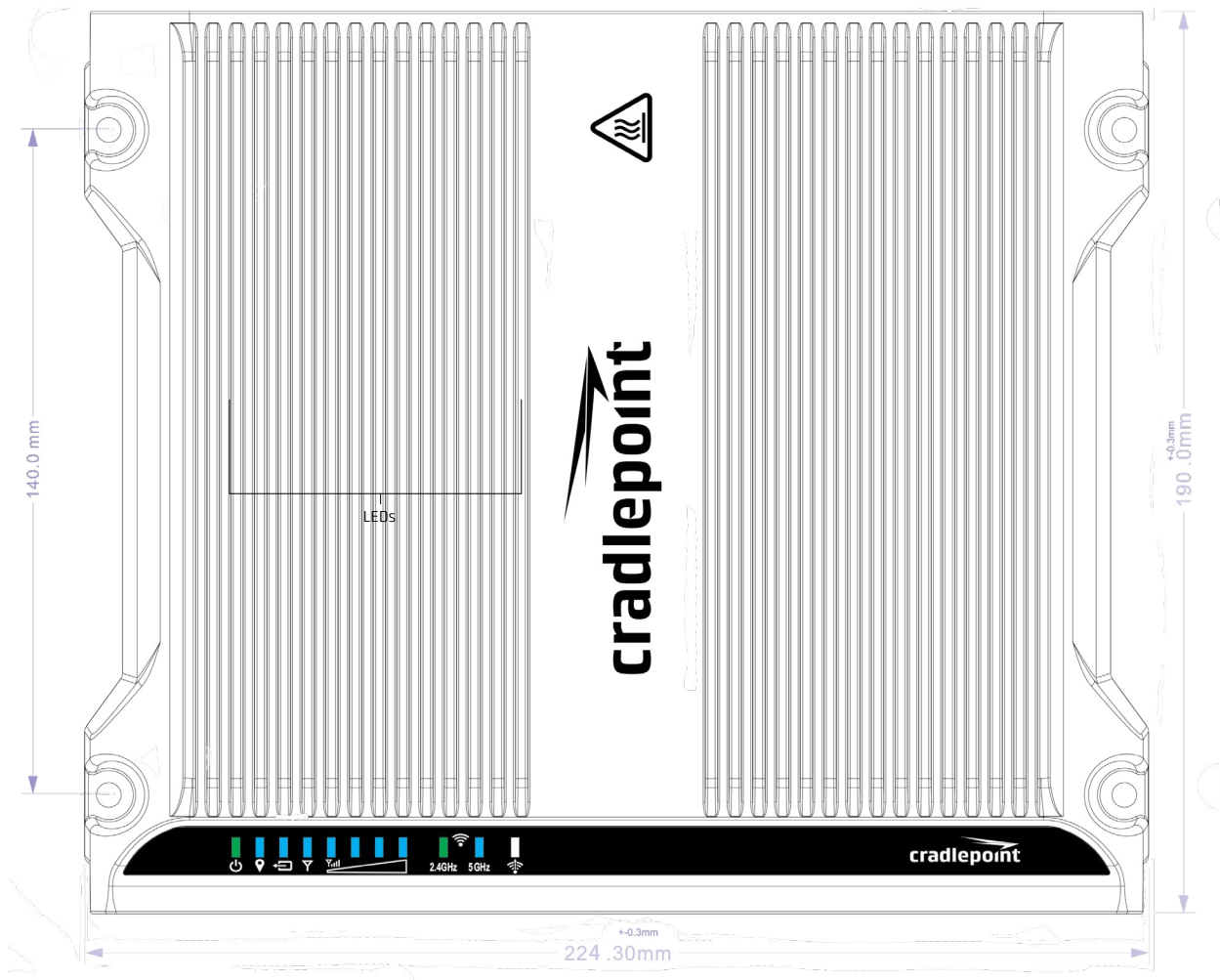

FRONT

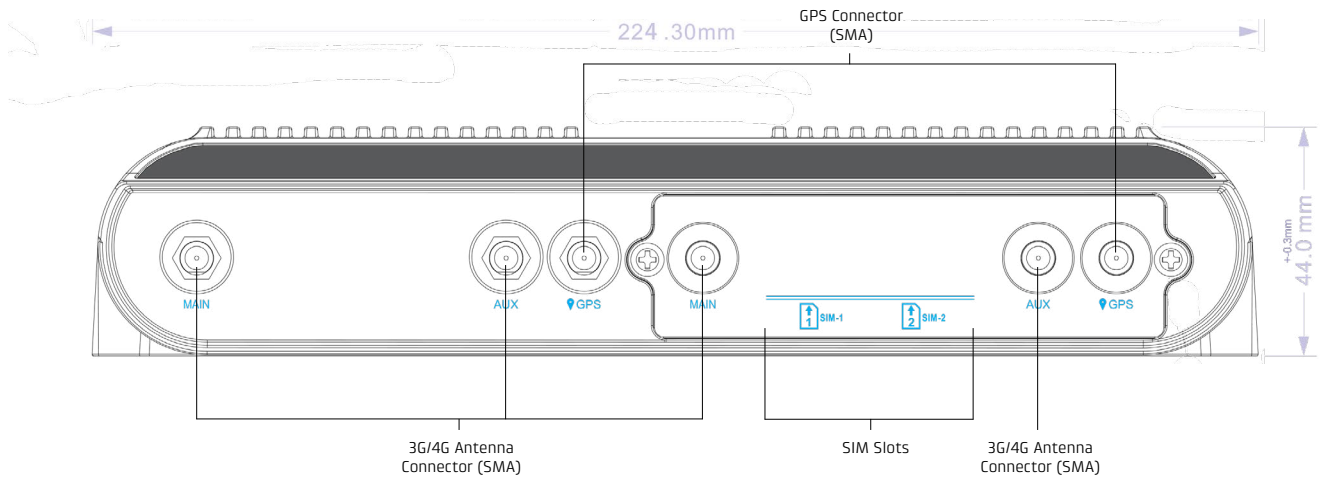



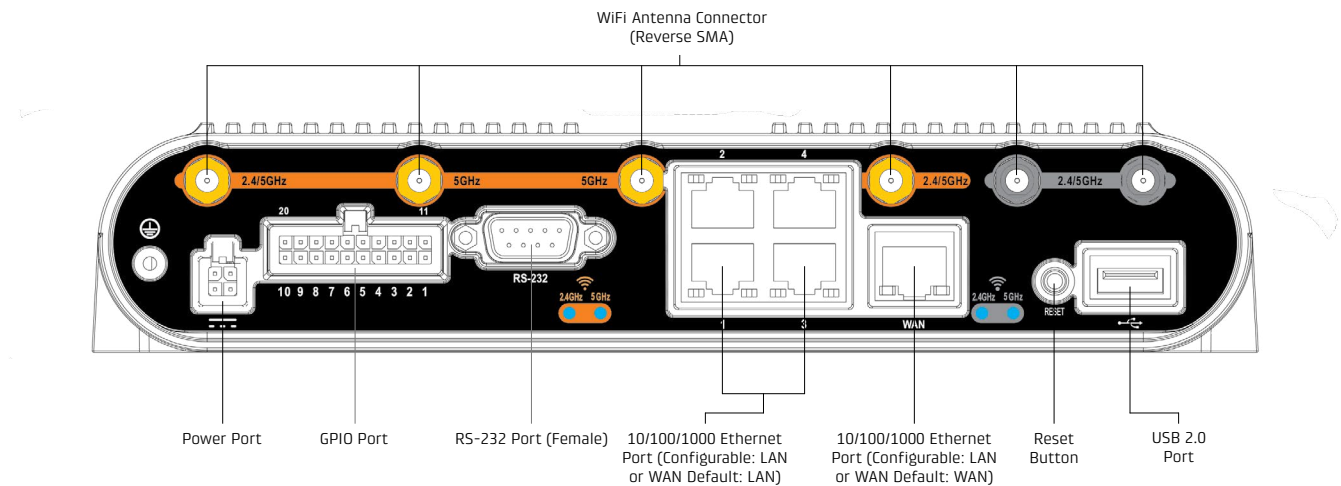



BACK



IBR1700 2x10 Connector

PIN	Bottom Row		
1	Router Voltage Input	6	GPIO1
2	Router Voltage Input	7	GPIO1
3	ADC Channel 1	8	GPIO1
4	ADC Channel 2	9	GPIO1
5	GPI / Ignition Sense	10	Low Current 5V Output (50mA max)
		11-20	GND

LEDS

INDICATOR	BEHAVIOR
	<p>POWER: The Cradlepoint IBR1700 must be powered using an approved 9–36 V DC power source.</p> <ul style="list-style-type: none"> • Green = Powered ON. • Yellow = Attention is required. • No Light = Not receiving power. Check the power switch and the power source connection.
	<p>GPS: Indicates the status of GPS connection.</p> <ul style="list-style-type: none"> • Blue = GPS locked. • Blinking Blue = Obtaining lock. • No Light = Off/no lock.
	<p>MC400 MODEM: Indicates information about the optional MC400 modem.</p> <ul style="list-style-type: none"> • Green = Modem has established an active connection. • Blinking Green = Modem is connecting. • Amber = Modem is not active. • Blinking Amber = Data connection error. No modem connection possible. • Blinking Red = Modem is in the process of resetting. • No Light = Modem not connected.
	<p>INTEGRATED MODEM: Indicates information about the integrated modem.</p> <ul style="list-style-type: none"> • Green = Modem has established an active connection. • Blinking Green = Modem is connecting. • Amber = Modem is not active. • Blinking Amber = Data connection error. No modem connection possible. • Blinking Red = Modem is in the process of resetting. • Blinking Red with Signal Strength LEDs = SIM door is not installed, modem is off. • No Light = Modem not connected.
	<p>SIGNAL STRENGTH: Blue LED bars indicate the active modem's signal strength.</p> <ul style="list-style-type: none"> • 4 Solid Bars = Strongest signal. • 1 Blinking Bar = Weakest signal. (A blinking bar indicates half of a bar.) • 4 Blinking Bars = SIM door is not installed, modem is off
<p>2.4GHz 5GHz</p>	<p>WIFI STATUS: Indicates information about WiFi channels.</p> <ul style="list-style-type: none"> • 2.4 GHz Green = Activity on 2.4 GHz WiFi band. • 5 GHz Blue = Activity on 5 GHz WiFi band.
	<p>WIFI AS WAN: Indicates WiFi as WAN status.</p> <ul style="list-style-type: none"> • White = WiFi as WAN active.
<p>Other</p>	<p>ADDITIONAL LED INDICATIONS:</p> <ul style="list-style-type: none"> • Several different LEDs blink when the factory reset button is detected. • Two of the modem LEDs blink red in unison for 10 seconds when there is an error during NCOS upgrade. • When an external USB modem is plugged in, only the Signal Strength LEDs will light up.