

Data Sheet

R2100 Series 5G Ruggedized Router



2024 - 09 - 09

The R2100 Series 5G Ruggedized Router is designed for vehicle and IoT deployments. This high-bandwidth, exterior-mounted solution provides mass transit, public safety, and other organizations with the latest cellular performance in a uniquely flexible and simplified form factor.

5G Ruggedized Router for High-Performance Vehicle and IoT Connectivity

The Cradlepoint R2100 Series 5G Ruggedized Router is available with the NetCloud Performance Mobile Service plan or the NetCloud Ruggedized IoT Service plan. Designed to be mounted on the roof of a vehicle or attached to IoT cabinet enclosures, the R2100 integrates the modem, antennas, and router into a single aerodynamic, ruggedized casing allowing for simplified deployment. The R2100 is sold with or without Wi-Fi 6 and can be deployed as a self-contained router or to supplement an existing router as a 5G adapter.

High Performance Captive Modem

Customers can add 5G to a current installation by deploying the R2100 Series as a Captive Modem with supported Cradlepoint controlling routers. This allows them both to be managed in NetCloud Manager as a single entity. The NetCloud management system treats the R2100 as an internal modem, eliminating the need for a separate license. Similarly, for select controlling routers, the R2100 Series can serve as an additional Wi-Fi source in captive mode to expand coverage for applications such as video offload. The R2100 Series can be PoE powered while providing a high-performance 5G connection over Ethernet.

Notable Benefits

- Deploy the integrated 5G NR / Cat 20 LTE modem, antenna, and Wi-Fi 6-equipped router in one complete package
- Install as a self-contained 5G router or supplement an existing router as a 5G adapter
- Provide easy installation with a power cable or Power over Ethernet (PoE) and no coax cables
- Define policies through centralized cloud-based management for easy deployment at scale
- Prioritize access on public safety networks for reliable, secure connectivity
- Create a cellular coverage map of your area's 5G and LTE
- Integrate into Automatic Vehicle Location systems with GNSS/GPS

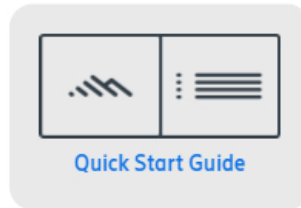
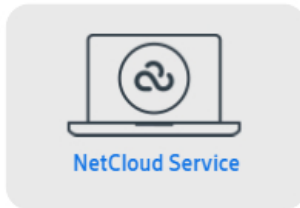
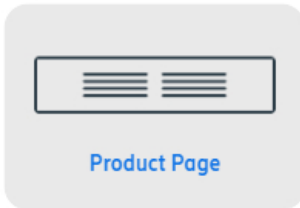

Key Software Capabilities

The R2100 Series 5G Ruggedized Router is enabled by a NetCloud Service subscription plan which includes everything needed to unlock the power of 5G at the network edge and connect devices to critical applications and services. It all works together, making it easy to deploy, connect, and secure edge applications at scale across the organization. The service includes a warranty for as long as there is an active subscription, online training, live and online support, and all software and firmware updates.

Coverage Map

NetCloud Advanced Mobile Performance Service uses GNSS/GPS and 5G/4G cellular health to provide precise analytics about location and signal strength. Data can be mapped to display both the current and historical locations of a vehicle, as well as generate detailed coverage maps that display cellular health, allowing users to gain operational insights and solve problems.

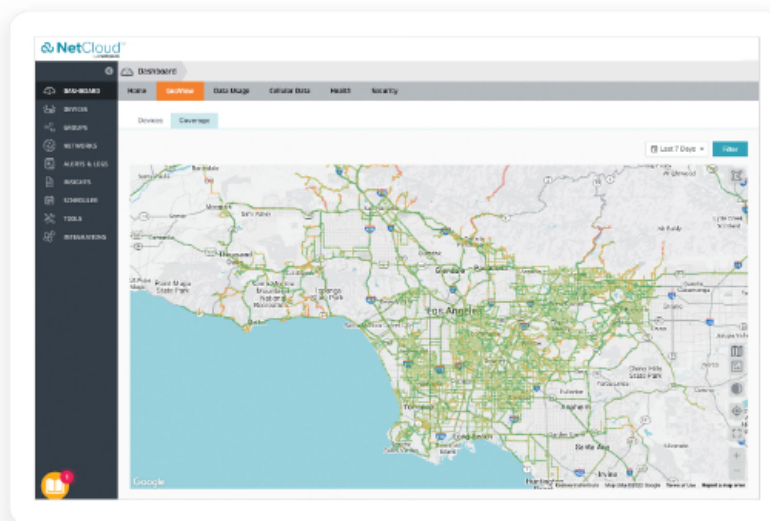

Advanced Software Lifecycle Management

NetCloud improves the typical software lifecycle management process. New features are continuously delivered to NetCloud and become available for the router without interrupting network performance. Software versions are tracked for every endpoint, with the latest update just a click away. Straightforward subscription and license management is easily accessible and provided to keep the network running without interruption.

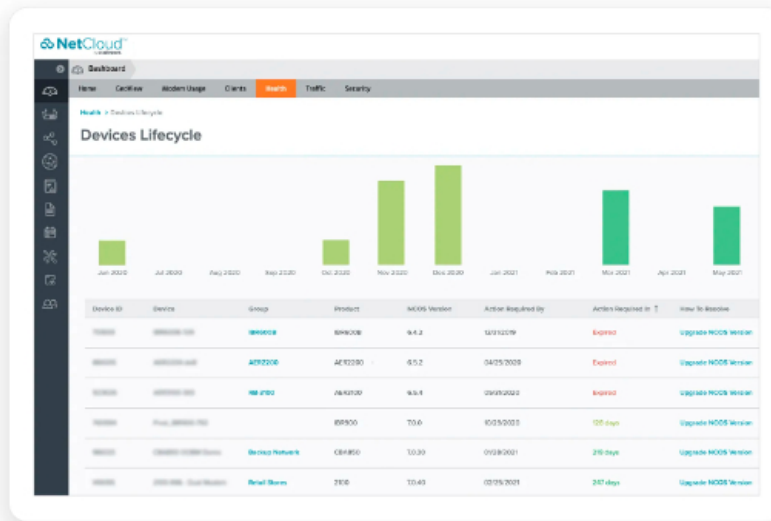

Security Services

NetCloud Advanced Mobile Performance Service includes security features that include application aware zone-based firewall, CP Secure Threat Management (IPS/IDS), and CP Secure Web Filter for protecting your network and meeting the evolving security needs of in-vehicle environments.

The R2100 supports NetCloud Exchange (NCX), a unified network and security WAN architecture built upon zero-trust principles and optimized for 5G. NCX helps lean IT organizations simplify deployment and management with shared policies and simplified processes.

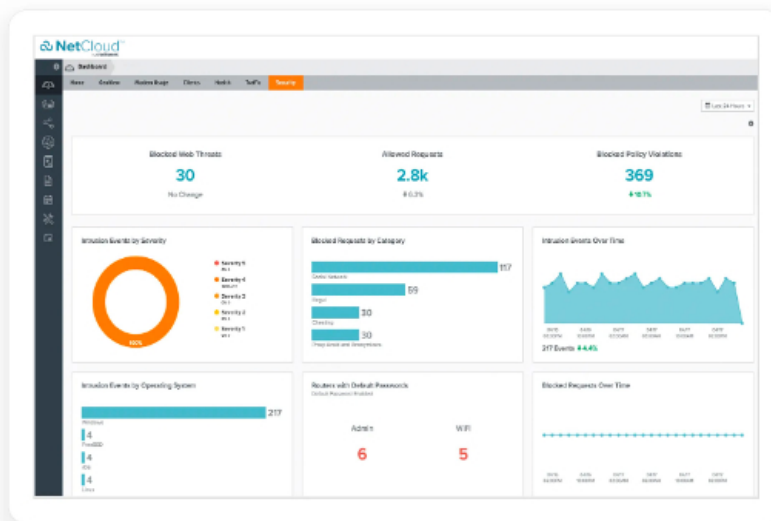

Connection Manager

Connection Manager provides the ability to manage all WAN connection types, including wireless, Wi-Fi as WAN, and wired, from a single software-defined policy. Our proprietary modem software enables users to quickly establish robust Wireless WAN connectivity while maintaining the highest level of resiliency.

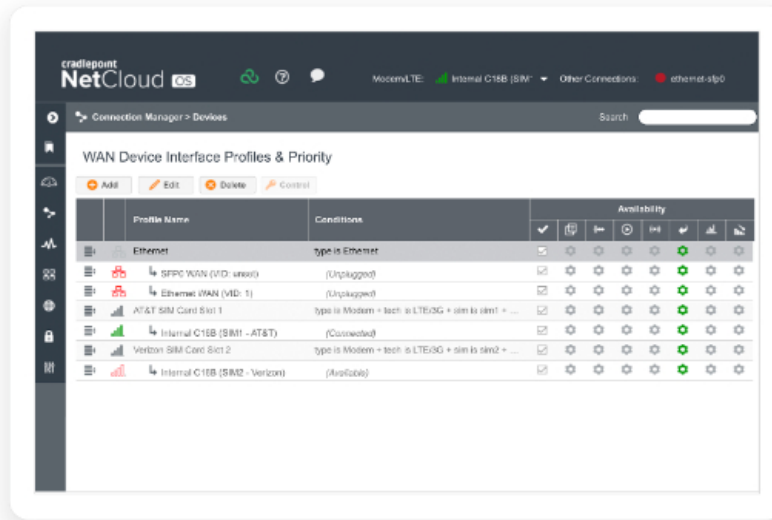

Hardware Specifications

The following features are delivered through the hardware.

INTERFACES	
Modem:	Embedded 5G NR FR1 low-, mid-band, and 4G LTE Category 20 modem
Ethernet:	1 x 2.5 GbE RJ45 (LAN only) <ul style="list-style-type: none"> — 18 in, non-removable CAT5e, shielded twisted pair, flat ethernet cable with male RJ45 connector
Wi-Fi:	Dual-radio, dual-band, concurrent operation (2.4 GHz and 5 GHz) <ul style="list-style-type: none"> — 2x2 MU-MIMO 802.11ax Wi-Fi 6 with DFS — Global Optimized Wi-Fi & International SDR — 5 GHz Wi-Fi use in the European Union is limited to client mode
Bluetooth:	N/A
Expansion / Console:	N/A
GNSS / GPS:	Passive GNSS (multiplex with internal cellular antennas)
ENVIRONMENTAL	
Temperature:	<ul style="list-style-type: none"> — Operating: -30 °C to 70 °C (-22 °F to 158 °F) — Storage: -40 °C to 85 °C (-40 °F to 185 °F)
Humidity:	<ul style="list-style-type: none"> — Operating: 5% to 95% — Storage: 5% to 95%
Ingress Protection / Corrosion:	<ul style="list-style-type: none"> — IP67 (dust tight and water immersion up to 1 meter) — IEC60068-2-11 corrosion resistance (salt mist)

Impact Protection:	IK09 (protected against 10 joules impact)
POWER	
Required:	<p>One of the following:</p> <ul style="list-style-type: none"> — DC input steady state voltage range: 9–36 VDC — 5.5 ft non-removable DC input cable with 4-pin 2x2 Molex micro-fit connector — For 9–24 VDC installations, use a 3 A fuse — For > 24 VDC installations, use a 2.5 A fuse — 802.3at PSE Type 2 (30 W)
Features:	<ul style="list-style-type: none"> — Ignition sensing (automatic ON & time-delay OFF)
Consumption:	<p>R2105:</p> <ul style="list-style-type: none"> — Sleep: 50 mW — Idle: 8 W — Typical: 14.5 W — Heavy: 17 W <p>R2155:</p> <ul style="list-style-type: none"> — Sleep: 50 mW — Idle: 6 W — Typical: 10 W — Heavy: 11.5 W <p>PoE:</p> <ul style="list-style-type: none"> — 802.3at Class 4 PD (30 W)
PHYSICAL	
Size:	115 x 386 x 82 mm (4.5 x 15.7 x 3.2 in)
Weight:	1.46 kg (3 lb 4 oz)
RELIABILITY	
Calculated MTBF:	1,895,792 hours (Telcordia SR332 at 25 °C)
CERTIFICATIONS	
Safety:	<ul style="list-style-type: none"> — CB Scheme — IEC/EN 62368-1
Vehicle:	<ul style="list-style-type: none"> — E-Mark — MIL-STD-810G — SAE J1455
Rail:	N/A

Materials:	<ul style="list-style-type: none"> — WEEE — RoHS — REACH — California Prop 65
Security:	FIPS 140-3 Level 1 Module in Process (R2100 FIPS models only)
EDGE COMPUTING	
CPU:	Quad-core ARMv8 64-bit
Memory:	Up to 1.8 GB See Adjusting Memory Resources for NetCloud Container Orchestrator for more information.
Flash Storage:	Up to 8 GB See Adjusting Memory Resources for NetCloud Container Orchestrator for more information.
Applications:	Docker containerized applications
CLOUD SERVICES	
Service Plans:	NetCloud Service for Mobile Performance, NetCloud Service for Ruggedized IoT
Service Add-Ons:	NetCloud Exchange, NetCloud Advanced
Support:	NetCloud Packages include support for the full subscription term.
Warranty:	All Cradlepoint hardware products are covered by a limited lifetime warranty for as long as they have a subscription license to an active NetCloud Service Plan.
Device Management:	NetCloud Manager for the full subscription term.
Software Updates:	NetCloud Manager for the full subscription term.
R2105 WI-FI POWER	
FCC:	<ul style="list-style-type: none"> — 2.4 GHz: 30.9 dBm EIRP — 5250–5350 MHz: 29.4 dBm EIRP — 5470–5725 MHz: 29.5 dBm EIRP — 5725–5850: 34.3 dBm EIRP
European Union:	<ul style="list-style-type: none"> — 2.4 GHz: 20.0 dBm EIRP — 5470–5725 MHz: 22.7 dBm EIRP
Canada:	<ul style="list-style-type: none"> — 2.4 GHz: 30.9 dBm EIRP — 5470–5725 MHz: 29.5 dBm EIRP — 5725–5850 MHz: 34.3 dBm EIRP
Global Safe Mode:	2.4 GHz: 20.0 dBm EIRP
PERFORMANCE	
Stateful Firewall Throughput:	900 Mbps
IPS Throughput:	650 Mbps
Application Aware Services & Analytics:	650 Mbps
IPsec VPN Throughput:	300 Mbps
Concurrent VPN Tunnels:	10
Concurrent Sessions (TPC):	32,000

Typical Client Count:	100
Layer 2 / Layer 3 VLANs:	Up to 64
LEDs	
See the R2100 Series Quick Start Guide .	

Performance testing was conducted based on requirements as defined in RFC2544 using fixed-frame 1518-byte packets. Throughput results reflect uni-directional UDP traffic with less than 1% packet loss as tested with wired connections. Results do not reflect performance of the cellular wireless operator networks.

Enterprise-Class Modem Specifications

SPECIFICATION	R2105-5GB / R2155-5GB
Technology:	5G FR1 NSA/SA and 4G LTE <ul style="list-style-type: none"> — LTE Advanced Pro Category 20 — Dual SIM slots, 4FF form factor — 3GPP Release 15
3G:	WCDMA/UMTS/HSPA+
Carrier Aggregation:	LTE Only <ul style="list-style-type: none"> — Downlink: Up to 7CA — Uplink: Up to 2CA LTE + 5G NR ENDC <ul style="list-style-type: none"> — Downlink: 1CA — Uplink: 1CA See Understanding Carrier Aggregation .
Peak Rates:	<ul style="list-style-type: none"> — Downlink: Up to 4.14 Gbps — Uplink: Up to 660 Mbps
MIMO:	4x4 MIMO
Modulation:	5GB FR1 <ul style="list-style-type: none"> — Downlink: Up to 256 QAM — Uplink: Up to 256 QAM. (Only enabled on particular carrier equipment from 9190 data sheet.)
4G/LTE Bands:	FDD <ul style="list-style-type: none"> — B1 (2100), B2 (1900), B3 (1800), B4 (1700), B5 (850), B7 (2600), B8 (900), B12 (700), B13 (700), B14 (700), B17 (700), B18 (850), B19 (850), B20 (800), B25 (1900), B26 (850), B28 (700), B29 (700), B30 (2300), B32 (1500), B66 (1700), B71 (600) TDD <ul style="list-style-type: none"> — B34 (2000), B38 (2600), B39 (1900), B40 (2300), B41 (2500), B42 (3500), B43 (3700), B46 (5200), B48 (3500)

5G NR Bands:	NSA and SA — n1 (2100), n2 (1900), n3 (1800), n5 (850), n7 (2600), n8 (900), n12 (700), n20 (800), n25 (1900), n26 (850), n28 (700), n38 (2600), n40 (2300), n41 (2500), n48 (3500), n66 (1700/2100), n71 (600), n77 (3700), n78 (3500), n79 (4900)
3G Bands:	B1, B2, B4, B5, B6, B8, B9, B19
Power:	LTE — LTE bands: 23 dBm ± 1 (typical conducted) — LTE HPUE: 25 dBm ± 1 (B41 standalone mode only) LTE + 5G NR ENDC — LTE + 5G NR: 20 dBm ± 1 (typical conducted) 5G NR — 5G NR bands: 23 dBm ± 1.5 (typical conducted)
Antennas:	4 x cellular internal antennas
GNSS/GPS:	Passive GNSS
SMS:	Yes
Regulatory:	FCC (U.S.), IC (Canada), CE (EU), RCM (AU/NZ)
Network Operator Standards:	PTCRB (U.S., Canada), GCF (Worldwide)
GCF Global Operators:	https://www.globalcertificationforum.org/membership/gcf-members.html [†]
PTCRB North America Operators:	https://www.ptcrb.com/about/
Network Operator Certifications:	AT&T, T-Mobile, Verizon [†]
Public Safety Network Certifications:	FirstNet Trusted TM , T-Mobile Connecting Heroes, Verizon Frontline
Private Cellular Network:	Yes, includes FCC Part 96 (CBRS Band 48)

[†]Cellular carriers and operators throughout the world may only require telecom industry certifications, like PTCRB or GCF, to operate on their network. Some carriers require additional testing and approval, beyond telecom certifications, to operate on their network. A carrier listed in the approvals section means Cradlepoint completed additional testing and acquired technical approval for that given carrier. Any carrier not listed may not require additional testing or approval beyond telecom industry certifications to operate on their network.

Physical Measurements & Features

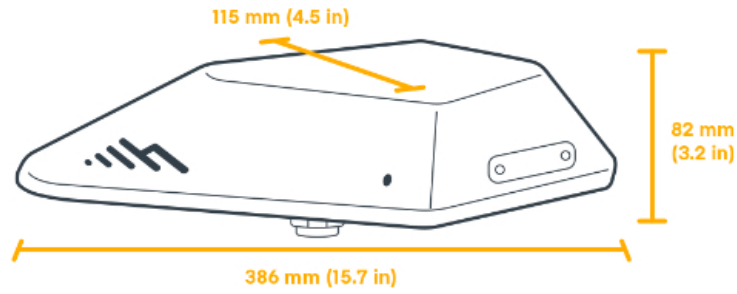

Features

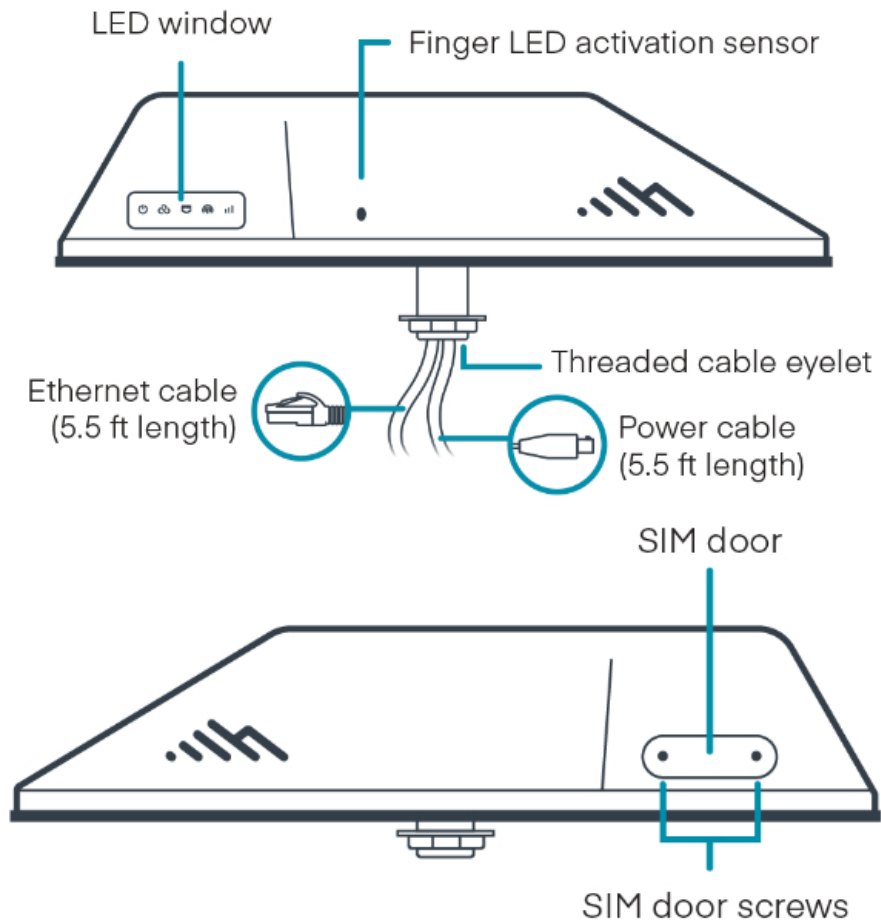

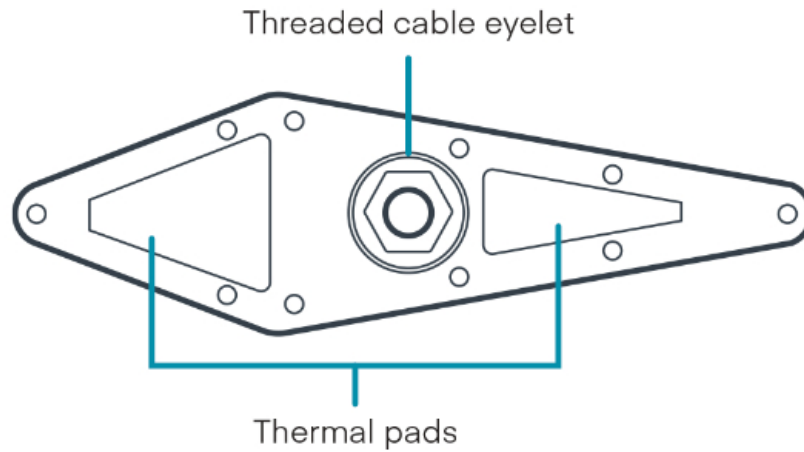

SIM Card Info

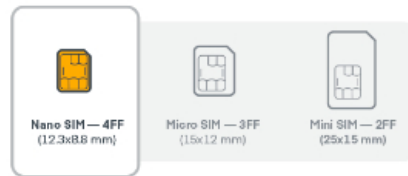

Ordering Guide

NetCloud Mobile Performance and NetCloud Ruggedized IoT packages include all the features and capabilities required to fulfill a broad range of mobile, in-vehicle, and IoT solutions. The base Essentials subscription includes a purpose-built endpoint, 24x7 support (phone support: 24-hour weekdays with emergency response on weekends, web: 24x7, chat: 24x5), a limited lifetime warranty, and access to Cradlepoint University. For additional feature capabilities, a NetCloud Advanced plan license can be added at any time to endpoints in the network. See additional details of what is included in the Essential and Advanced NetCloud software: cradlepoint.com/netcloud-service

NetCloud Mobile Performance Packages for the R2100 Series Router

REGION	MODEM	MOBILE PACKAGE PLAN	PART NUMBER
All Regions:	R2105 5G router with Wi-Fi (Mobile)	Mobile Performance Essentials	MB0x-2105-5GB-GA
	— 4FF SIM optional but not included, integrated antennas, no AC power supply	Mobile Performance Essentials + Advanced	MBAx-2105-5GB-GA
	R2105 5G router with Wi-Fi (IoT)	Ruggedized IoT Essentials	TC0y-2105-5GB-GA
	— 4FF SIM optional but not included, integrated antennas, no AC power supply	Ruggedized IoT Essentials + Advanced	TCAy-2105-5GB-GA

	R2155 5G router without Wi-Fi (Mobile)	Mobile Performance Essentials	MB0x-2155-5GB-GA
	— 4FF SIM optional but not included, integrated antennas, no AC power supply	Mobile Performance Essentials + Advanced	MBAx-2155-5GB-GA
	R2155 5G router without Wi-Fi (IoT)	Ruggedized IoT Essentials	TC0y-2155-5GB-GA
	— 4FF SIM optional but not included, integrated antennas, no AC power supply	Ruggedized IoT Essentials + Advanced	TCAy-2155-5GB-GA
		Adapter Advanced (requires corresponding Essentials Plan)	MC0x-NCADV
United States: Federal Government	R2105 5G router with Wi-Fi (Mobile)	TAA Complaint NC Mobile Performance Essentials	TAA-MB0y-2105-5GB-GA
	— 4FF SIM optional but not included, integrated antennas, no AC power supply	TAA Complaint NC Mobile Performance Essentials + Advanced	TAA-MBAy-2105-5GB-GA
	R2105 5G router with Wi-Fi (IoT)	TAA Complaint NC Ruggedized IoT Essentials	TAA-TC0y-2105-5GB-GA
	— 4FF SIM optional but not included, integrated antennas, no AC power supply	TAA Complaint NC Ruggedized IoT Essentials + Advanced	TAA-TCAy-2105-5GB-GA
	R2105 5G router with Wi-Fi (Mobile)	TAA Complaint NC Mobile FIPS Performance Essentials + Advanced	TAA-MBAy-2105-5GB-FA
	— 4FF SIM optional but not included, integrated antennas, no AC power supply		
	R2105 5G router with Wi-Fi (IoT)	TAA Complaint NC FIPS Ruggedized IoT Essentials + Advanced	TAA-TCAy-2105-5GB-FA
	— 4FF SIM optional but not included, integrated antennas, no AC power supply		
	R2155 5G router without Wi-Fi (Mobile)	TAA Complaint NC Mobile Performance Essentials	TAA-MB0y-2155-5GB-GA
	— 4FF SIM optional but not included, integrated antennas, no AC power supply	TAA Complaint NC Mobile Performance Essentials + Advanced	TAA-MBAy-2155-5GB-GA
	R2155 5G router without Wi-Fi (IoT)	TAA Complaint NC Ruggedized IoT Essentials	TAA-TC0y-2155-5GB-GA
	— 4FF SIM optional but not included, integrated antennas, no AC power supply	TAA Complaint NC Ruggedized IoT Essentials + Advanced	TAA-TCAy-2155-5GB-GA

	R2155 5G router without Wi-Fi (Mobile) — 4FF SIM optional but not included, integrated antennas, no AC power supply	TAA Complaint NC Mobile FIPS Performance Essentials + Advanced	TAA-MBAy-2155-5GB-FA
	R2155 5G router without Wi-Fi (IoT) — 4FF SIM optional but not included, integrated antennas, no AC power supply	TAA Complaint NC FIPS Ruggedized IoT Essentials + Advanced	TAA-TCAy-2155-5GB-FA
Renewals:		Renewal Mobile Performance Essentials	MB0x-NCESS-R
		Renewal Mobile Performance Advanced	MB0x-NCADV-R
		Renewal Mobile Performance Essentials + Advanced	MBAx-NCEA-R
		Renewal Ruggedized IoT Essentials	TC0x-NCESS-R
		Renewal Ruggedized IoT Advanced	TC0x-NCESS-R
		Renewal Ruggedized IoT Essentials + Advanced	TC0x-NCADV-R
			TCAx-NCEA-R
All Regions:	R2105 5G Captive Modem and Wi-Fi Accessory	N/A	170900-014
	R2155 5G Captive Modem Accessory	N/A	170900-015

x = 1, 3, or 5 years

y = 3 or 5 years

Accessories

INCLUDED	PART NUMBER
GPIO Cable, 2x2, 3 meters, 20 AWG	170864-000
Small Accessories Kit	N/A
Mounting Template	N/A
OPTIONAL	
Power Supply, 12V, 2x2 Small 1.5 meters (North America Type A)	170716-001
Power Supply, 12 V, Small 2x2, 1.5 meters (North America-United Kingdom-Europe-Australia Types A-G-C-I)	170717-000
Vehicle Mounting Foam	170905-000
Vehicle Mounting Extension Bolt	170906-000

Support & Warranty

The R2100 Series 5G Ruggedized Router is only sold as a component of NetCloud Mobile Performance Essentials or Essentials + Advanced Packages.

- NetCloud Packages include support for the full subscription term.
- All Cradlepoint hardware products are covered by a limited lifetime warranty for as long as they have a subscription license to an active NetCloud Service Plan.

More Information

[Find the most up-to-date information at **cradlepoint.com/r2100**](https://www.cradlepoint.com/r2100)